

99630

Dimensions

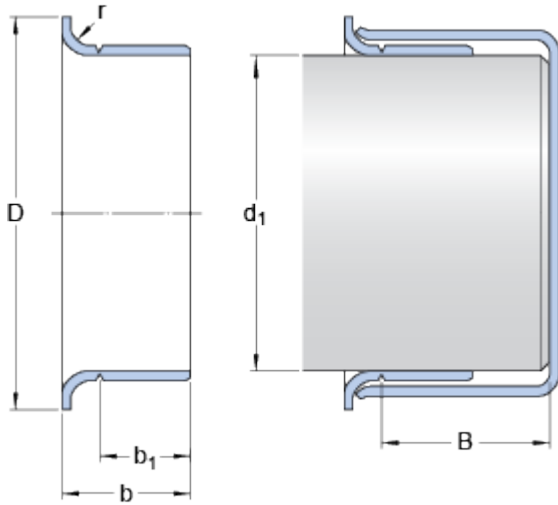

Nominal dimensions

d_1		160	mm
D		171.45	mm
Tolerance outside diameter D	\pm	1.6	mm
b		31.75	mm
Tolerance width b	\pm	0.8	mm
b_1		25.4	mm
Tolerance width b_1	\pm	0.8	mm
B	max.	34.925	mm
r	max.	3.18	mm

Shaft diameter range

d_1	min.	159.741	mm
d_1	max.	159.995	mm